

Understanding and Specifying Steelcase Series 1 Work Chairs

Product Details

Steelcase Series 1	94
Steelcase Series 1 Upholstery	97
Dimensions	98

Specifying

Work Chair

3D Microknit with Standard Upholstery on Seat	100
---	-----

Stool

3D Microknit with Standard Upholstery on Seat	102
---	-----

Accessories

	104
--	-----

Work Chairs

Highly adjustable task seating offers maximum personalization for fit and comfort for a range of duration and use. By making a series of simple adjustments, you can customize the chair to your body, preferences, and tasks. These chairs provide continuous, stable, comfort, and can be quickly adjusted to support you in upright, and reclining work postures.

- Gesture 442 Series
- Leap 462 Series
- Think 465 Series
- Amia 482 Series
- Reply 466 Series
- Jersey Series
- Leap 464 Series
- WorkLounge
- Criterion 453 Series

Adjustability Features

▶ See page 30 for a comparison to other chairs. **Steelcase Series 1**

Mechanisms

Weight-activated ●

Seat Adjustments

Pneumatic height ●

Seat depth ●

Back Adjustments

Lumbar height ●

Arm Adjustments

Arm height ●

Arm width ●

Arm pivot ●

Arm depth ●

Other Features

Foot ring height (stool) ●

Steelcase Series 1

Steelcase Series 1

makes high-quality seating attainable for everyone, everywhere. It delivers performance, style, and choice unprecedented in its class of seating.

Back frame and seat shell are plastic.

Lumbar height adjusts over 2 $\frac{1}{4}$ " to provide additional lower back support.

Arm caps can pivot independently 40° inward and 40° outward to accommodate individual user preferences.

Seat height adjusts within a 5" range with a pneumatic adjustment mechanism. Short or tall range is available as an option. Stools have a 7 $\frac{3}{4}$ " range.

Comfort dial back control provides three settings for the user's personal preference and work style.

Casters have hard, dual-wheels that roll smoothly on carpets. They are 2 $\frac{1}{2}$ " for increased mobility. Soft, dual-wheel roll-control casters are available as an option for use on hard floors or chair mats. Glides are also available as an option.

Tip: Do not roll the chair across asphalt during installation as this may damage the casters.

Arm height can adjust independently within a 5" range to help relieve upper back and shoulder fatigue.

Arm width adjusts 4" overall to support forearms in neutral position.

Arm depth can retract 2" to allow user to get closer to the worksurface and into tight corners.

Seat depth adjusts within a 2 $\frac{1}{4}$ " range to accommodate users of varying leg lengths.

Five-arm base is available in paint, plastic, or polished aluminum.

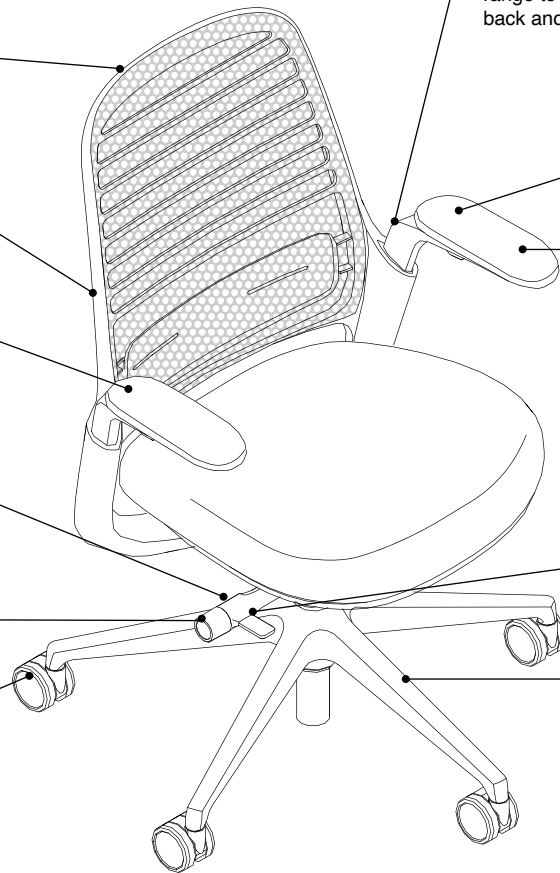

Product Details

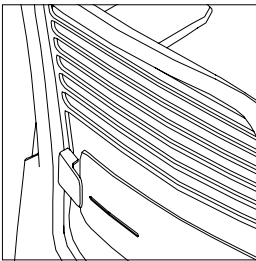

Integrated LiveBack System dynamically supports and follows the movements of the user.

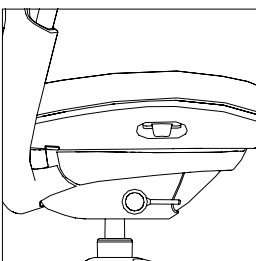

Advanced weight-activated mechanism with a natural fluid motion keeps users oriented to their work.

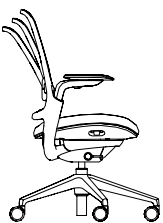

Comfort dial has three settings that allow for the user's personal preference and work style.

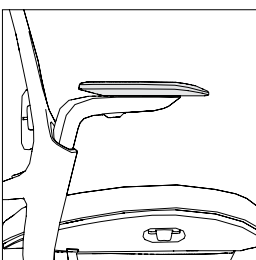

Pill arms with soft caps are standard.

Uncartoned request on your dealer purchase order means Steelcase Series 1 chairs will ship fully assembled.

Cartoned request on the dealer purchase order means Steelcase Series 1 chairs will ship knocked down in seven pieces. This allows for shipment in a smaller carton. Assembly does not require tools.

Tip: Assembly instructions are included on the box.

Product Weight

- Series 1 chair: 29.2 pounds

Adjustment Features

Adjustability instructions are included with every chair.

Seat Adjustments

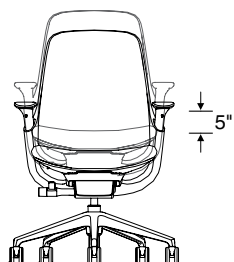

Seat height adjusts pneumatically. To lower, hold handle up while seated. To raise, hold handle up and keep your weight off the chair. Standard range of adjustability is 5" from 16¹/₂"H to 21¹/₂"H. A short 3" range of adjustability (14³/₄" to 17³/₄") and a tall 4³/₄" range of adjustability (17¹/₄" to 22") is available as an option. A 7³/₄" range of adjustability (23" to 30³/₄") is available on stools.

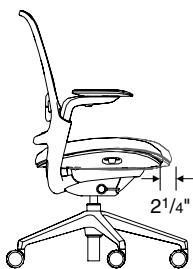

Seat depth adjusts 2¹/₄" (15¹/₂"–17³/₄") by pulling handle up. Slide seat forward or back to accommodate various leg lengths. Release handle to lock.

Back Adjustments

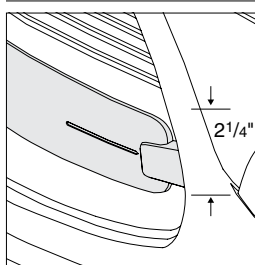

Lumbar height adjusts 2¹/₄" (6¹/₂" to 8³/₄" from seat) by grabbing exposed tabs and sliding the lumbar support up or down.

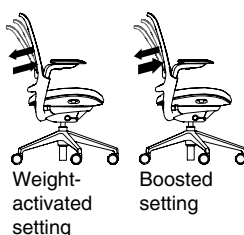

Upright setting

Comfort dial has three settings: (1) weight-activated setting; (2) boosted setting that has more resistance than your body is providing; and (3) an upright back lock setting.

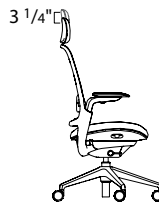

Headrest adjusts 3¹/₄" vertically to support the head and neck of the user in both upright and recline postures. The plastic stalk and underside of the headrest will coordinate to match the frame color specified: black or seagull. The foam pad of the headrest is available in eleven 3D Microknit colors. Whether ordered initially or at a later date, the headrest ships in its own carton and must be field installed.

Arm Adjustments

Rectilinear height-, width-, pivot-, and depth-adjustable arms come standard on all arm models of chairs and stools.

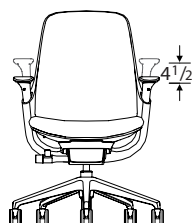

Arm height adjusts independently within a range of 4¹/₂" (6¹/₂"–11" from the seat). Push button on outside and under arm cap in while moving arms up or down. Releasing buttons locks arms in position.

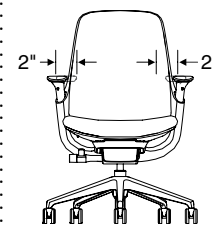

Arm width can be adjusted 2" each, 4" overall. Grasp arm cap and move in or out.

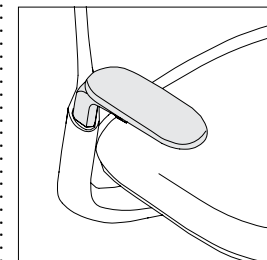

Arms pivot independently, 40° inward and outward. Grasp arm and push front to left or right.

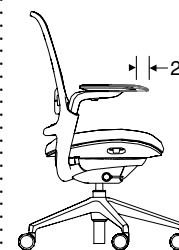

Arm depth adjusts by sliding arm caps back 2". Friction-fit mechanism keeps arms in position.

Steelcase Series 1, continued

Other Features

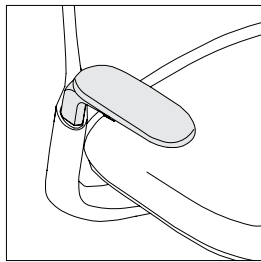

Height-only adjustable arm is also available and adjusts 4 1/2".



Armless models are also available.

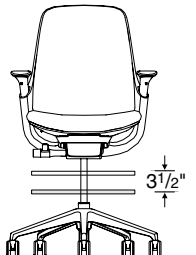

Foot ring height on stools adjusts by rotating it counterclockwise to unlock. Then raise or lower ring to desired position before rotating it clockwise to lock. The foot ring has a diameter of 20".

Soft dual-wheel roll-control casters feature an internal brake that activates when the chair is not under load to reduce shifting when user stands up.

Surface Materials

▶ See *Surface Materials* on page 774 for specific availability or refer to the *Surface Materials Reference Manual* for further information.

Upholstery

- Fabric
- Fabric with soil-retardant treatment (option)
- 3D Microknit (back and headrest only)
- Elmosoft leather
- Select Surfaces leather
- Leather
- Vinyl

Hard components

Back frame, stools ring, headrest, and hanger

- 6053 Seagull
- 6205 Black

Base

- 6205 Black
- 7243 Seagull
- 8046 Polished Aluminum

Pneumatic cylinders

- 6205 Black

Flexors and lumbar finishes are determined by the 3D Microknit color unless specified as contrasting.

Seat shell is determined by the frame finish.

- 6053 Seagull
- 6205 Black

- Arms**
- 6059 Sterling Dark (on seagull chair)
 - 6205 Black (on black chair)

All Steelcase seating with standard upholstery fabrics complies with requirements of the State of California Technical Bulletin 117-2013. All standard seating is labeled to be in compliance with California 117-2013.

Programs & Services

▶ See *Surface Materials Reference Manual* for further detail about programs and services offered for seating.

The Customer's Own Material (COM) Program

offers the opportunity for customers to select fabrics that are not offered through the standard Steelcase surface materials program for use on Steelcase products. Through the COM program, Steelcase will test your materials for application on Steelcase products. Once approved, you can place your order. Steelcase will facilitate the entire ordering process and give you a production schedule. Steelcase will order the COM fabric directly from the textile manufacturer. For up-to-date information regarding fabric test results for all COM fabrics and details regarding yardage requirements for most seating lines, visit the COM website. To locate the COM website:

- Visit www.steelcase.com

Soil retardants are treatments that provide long-term soil and stain resistance to a fabric without affecting the shade or the integrity of the fabric. The following Steelcase Textiles are available pre-treated with soil retardant. (You do not need to select the soil-retardant option for these fabrics and incur the upcharge.)

- Jacks
- Link

For information on soil retardant fabrics on Select Surfaces, please refer to the *Surface Materials Reference Manual*.

Soil-retardant treatment is available on all other seating fabrics at an additional upcharge per seating unit. To order this option, please select "Soil-Retardant Treatment" under "Optional Accessories."

For soil-retardant treatment on COMs, please select "Soil-Retardant Treatment" under "Optional Accessories." Minimums or additional yardage may be required. Please contact the vendor directly for specific information.

Extended lead times may be necessary for this service.

Contact your Steelcase Solutions Fulfillment Team Representative at 1.888.STEELCASE (1.888.783.3522) or send an email to lineone@steelcase.com.

Dimensions

▶ Page 98

What Is It?

3D Microknit on Back only

Back

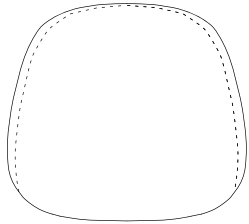
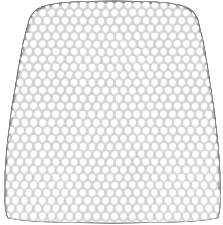

Seat

Fabric, leather, or vinyl-covered seat; 3D Microknit back only

Stitched seams are included on the seat cushion of the following:

- Leather
- Vinyl
- Upholstery
- Select Customer's Own Material/Vinyl (COM)

Tip: There are no stitching seams in Cogent:Connect.

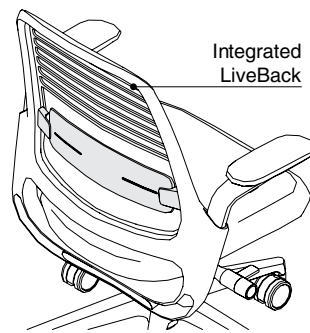

Integrated LiveBack

Back flexors are fully exposed. Lumbar and flexor colors always match. Lumbar and flexors will also match the 3D Microknit fabric unless contrasting is selected.

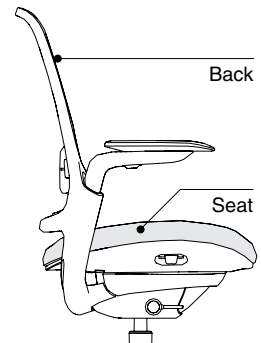

Back

Seat

Seat and back assemblies can be removed and replaced if damaged.

Dimensions

Steelcase Series 1

Features	Overall Depth	Width	Height	Seat Depth	Functional Seat Depth	Seat Width	Seat Height from Floor	Ring Height from Floor	Back Width	Back Height from Seat	Lumbar Height from Seat
----------	---------------	-------	--------	------------	-----------------------	------------	------------------------	------------------------	------------	-----------------------	-------------------------

Steelcase Series 1

Chair

Arms	21" to 23 ³ / ₄ "	23 ¹ / ₂ " to 27"	36 ¹ / ₂ " to 41 ¹ / ₄ "	18 ¹ / ₂ "	15 ¹ / ₂ " to 17 ³ / ₄ "	19 ¹ / ₂ "	16 ¹ / ₂ " to 21 ¹ / ₂ " (14 ³ / ₄ " to 17 ³ / ₄ ", 17 ¹ / ₄ " to 22" optional)	N.A.	17 ¹ / ₄ "	21 ¹ / ₂ "	6 ¹ / ₂ " to 8 ³ / ₄ "
------	---	---	--	----------------------------------	--	----------------------------------	---	------	----------------------------------	----------------------------------	--

Stool

Arms	21" to 23 ³ / ₄ "	23 ¹ / ₂ " to 27"	42 ¹ / ₄ " to 50"	18 ¹ / ₂ "	15 ¹ / ₂ " to 17 ³ / ₄ "	19 ¹ / ₂ "	23" to 30 ³ / ₄ "	11 ¹ / ₂ " to 15"	17 ¹ / ₄ "	21 ¹ / ₂ "	6 ¹ / ₂ " to 8 ³ / ₄ "
------	---	---	---	----------------------------------	--	----------------------------------	---	---	----------------------------------	----------------------------------	--

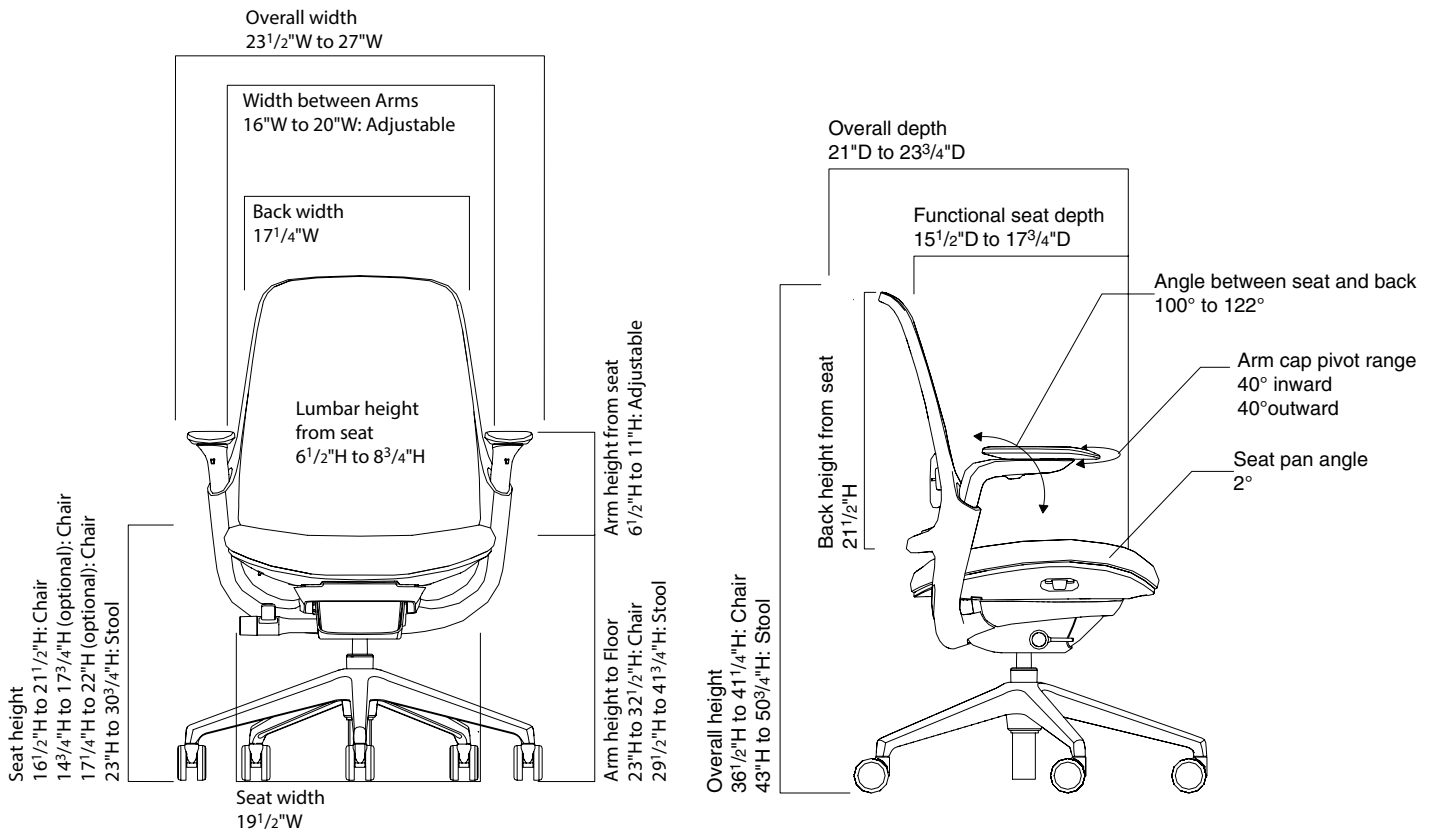

• Width • Between • Adjustable • Arms	• Width • Between • Height- • Adjustable • Arms	• Arm • to • Floor	• Arm • Height • from • Seat	• Arm Cap • Pivot • Range	• Angle • Between • Seat and • Back	• Seat • Pan • Angle	• Headrest • Height • Adjustment • Range
--	---	--------------------------	---------------------------------------	---------------------------------	--	----------------------------	---

16" to 20½"	19"	23" to 32½"	6½" to 11"	40° outward 40° inward	100° to 122°	2°	3¼"
-------------	-----	-------------	------------	---------------------------	--------------	----	-----

16" to 20½"	19"	29½" to 41¾"	6½" to 11"	40° outward 40° inward	100° to 122°	2°	3¼"
-------------	-----	--------------	------------	---------------------------	--------------	----	-----

Steelcase Series 1 Work Chair

3D Microknit with Standard Upholstery on Seat



Standard Includes		Required to Specify
<ul style="list-style-type: none"> ▶ Need help? Product details, page 94 	<ul style="list-style-type: none"> • 5" pneumatic seat-height adjustment (16½"–21½") • Frame: plastic • Base: paint or plastic • 2½" seat depth adjustment • Pill height-, width-, pivot-, and depth-adjustable arms • Adjustable lumbar • Back: 3D Microknit on back • Standard upholstery design on seat: fabric price group 1 • 2½"-diameter, hard-composition, dual-wheel casters: black only 	<ol style="list-style-type: none"> 1 Style number 2 Frame (see below under Required Selections) 3 3D Microknit color number for back 4 Plastic color number for outer back, if contrasting outer back is selected 5 Fabric color number for upholstery on seat 6 Plastic color number for base: <ul style="list-style-type: none"> 6205 Black (black and seagull frame) 7243 Seagull (seagull frame only) 7 Options, if selected (see below) <ul style="list-style-type: none"> ▶ See <i>Surface Materials</i>, page 774.

	Required Selections	U.S. Price	Required to Specify
Frame	<ul style="list-style-type: none"> • Black color scheme • Seagull color scheme 	No cost +\$ 38	Specify with 6205 Black. Specify with 6053 Seagull.

	Options	U.S. Price	Required to Specify
Surface Materials	Upholstery on seat		
	• Fabric price group 1	No cost	Specify fabric color number.
	• Fabric price group 2	+\$ 10	Specify fabric color number.
	• Fabric price group 3	+\$ 29	Specify fabric color number.
	• Fabric price group 4	+\$ 40	Specify fabric color number.
	• Fabric price group 5	+\$ 51	Specify fabric color number.
	• Fabric price group 6	+\$ 63	Specify fabric color number.
	• Fabric price group 7	+\$ 70	Specify fabric color number.
	• Fabric price group 8	+\$ 92	Specify fabric color number.
	• Fabric price group 9	+\$113	Specify fabric color number.
• Fabric price group 10	+\$128	Specify fabric color number.	
• Steelcase leather upholstery	+\$198	Specify leather color number.	
• Select Surfaces leather price group 1	+\$198	▶ See <i>Surface Materials Reference Manual</i> . Specify Elmosoft leather color number.	
• Elmosoft leather upholstery	+\$232	▶ See <i>Surface Materials Reference Manual</i> .	
• Select Surfaces leather price group 2	+\$232	▶ See <i>Surface Materials Reference Manual</i> .	
• Customer's Own Material (COM)	No cost		
	Soil-retardant treatment	+\$ 30	Specify with soil-retardant treatment.
	Back color scheme		
	• Contrasting outer back	+\$ 13	Specify with contrasting outer back and select plastic color number.
Arms	<ul style="list-style-type: none"> • Height-only adjustable • Armless 	-\$ 10 -\$ 73	Specify with height-only adjustable. Specify without arms.
Base	<ul style="list-style-type: none"> • Black • Polished aluminum base 	No cost +\$153	Specify with black base. Specify with aluminum base.
Headrest	• Headrest	+\$134	Specify with headrest.
Coat Hanger	• Coat hanger	+\$ 37	Specify with coat hanger.
Lumbar	<ul style="list-style-type: none"> • Adjustable lumbar • Fixed lumbar 	No cost No cost	Specify with adjustable lumbar. Specify with fixed lumbar.
Seat Height	<ul style="list-style-type: none"> • 3¼" low-range pneumatic seat-height adjustment • 4¾" high-range pneumatic seat-height adjustment 	+\$ 69 +\$ 69	Specify with short-range pneumatic seat-height adjustment. Specify with tall-range pneumatic seat-height adjustment.
Casters	• Soft, dual-wheel roll-control casters for use on hard floors	+\$ 30	Specify with soft roll-control casters.
Glides	• Plastic glides	+\$ 30	Specify with glides.

Tip: When ordering seagull frame the arms are 6059 Sterling Dark Solid. When ordering black frame, arms are black.

Tip: 3D Microknit, lumbar, and back flexors colors match unless contrasting outer back is selected.

Tip: Base finish matches frame finish, unless seagull frame is selected, then black base is also available.

Tip: Order black base on seagull frame for lowest maintenance.

Tip: A headrest and a coat hanger cannot be attached on a Steelcase Series 1 chair simultaneously.

▶ Detailed dimensions, page 98

Specification Information

• Style • Number	• U.S. • Base • Price
435A00	\$829



Steelcase Series 1



For Canadian Pricing
Multiply U.S. Price by the
Canadian price factor.
▶ See page 1 for details.

Steelcase Series 1 Stool

3D Microknit with Standard Upholstery on Seat



Standard Includes	Required to Specify
-------------------	---------------------

<p>► Need help? Product details, page 94</p> <ul style="list-style-type: none"> • 7¾" pneumatic seat-height adjustment (23"-30¾") • Frame: plastic • Base: plastic • 2¼" seat depth adjustment • Pill height-, width-, pivot-, and depth-adjustable arms • Column and adjustable foot ring: black • Adjustable lumbar • Back: 3D Microknit • Standard upholstery design on seat: fabric price group 1 • 2½"-diameter, hard-composition, dual-wheel casters: black only 	<ul style="list-style-type: none"> 1 Style number 2 Frame (see below under Required Selections) 3 3D Microknit color number for back 4 Plastic color number for outer back, if contrasting outer back is selected 5 Fabric color number for upholstery on seat 6 Plastic color number for base: 6053 Seagull (seagull frame only) 6205 Black (black and seagull frame) 7 Options, if selected (see below) <p>► See <i>Surface Materials</i>, page 774.</p>
--	---

Required Selections	U.S. Price	Required to Specify
---------------------	------------	---------------------

Frame	<ul style="list-style-type: none"> • Black color scheme No cost • Seagull color scheme +\$ 38 	<p>Specify with 6205 Black. Specify with 6053 Seagull.</p>
--------------	---	--

Options	U.S. Price	Required to Specify
---------	------------	---------------------

Surface Materials	Upholstery on seat	<ul style="list-style-type: none"> • Fabric price group 1 No cost • Fabric price group 2 +\$ 10 • Fabric price group 3 +\$ 29 • Fabric price group 4 +\$ 40 • Fabric price group 5 +\$ 51 • Fabric price group 6 +\$ 63 • Fabric price group 7 +\$ 70 • Fabric price group 8 +\$ 92 • Fabric price group 9 +\$113 • Fabric price group 10 +\$128 • Steelcase leather upholstery +\$198 • Select Surfaces leather price group 1 +\$198 • Elmosoft leather upholstery +\$232 • Select Surfaces leather price group 2 +\$232 • Customer's Own Material (COM) No cost 	<p>Specify fabric color number. Specify fabric color number. Specify fabric color number. Specify fabric color number. Specify fabric color number. Specify fabric color number. Specify fabric color number. Specify fabric color number. Specify fabric color number. Specify fabric color number. Specify fabric color number. Specify leather color number.</p> <p>► See <i>Surface Materials Reference Manual</i>. Specify Elmosoft leather color number. ► See <i>Surface Materials Reference Manual</i>. ► See <i>Surface Materials Reference Manual</i>.</p>
	Soil-retardant treatment	<ul style="list-style-type: none"> • Soil-retardant treatment +\$ 30 <p>Specify with soil-retardant treatment.</p>	
	Back color scheme	<ul style="list-style-type: none"> • Contrasting outer back +\$ 13 <p>Specify with contrasting outer back and select plastic color number.</p>	
Arms	<ul style="list-style-type: none"> • Height-only adjustable -\$ 10 • Armless -\$ 73 	<p>Specify with height-only adjustable. Specify without arms.</p>	
Base	<ul style="list-style-type: none"> • Plastic base No cost • Polished aluminum base +\$153 	<p>Specify plastic color number. Specify with aluminum base.</p>	
Headrest	<ul style="list-style-type: none"> • Headrest +\$134 	<p>Specify with headrest.</p>	
Coat Hanger	<ul style="list-style-type: none"> • Coat hanger +\$ 37 	<p>Specify with coat hanger.</p>	
Lumbar	<ul style="list-style-type: none"> • Adjustable lumbar No cost • Fixed lumbar No cost 	<p>Specify with adjustable lumbar. Specify with fixed lumbar.</p>	
Casters	<ul style="list-style-type: none"> • Soft, dual-wheel roll-control casters for use on hard floors +\$ 30 	<p>Specify with soft roll-control casters.</p>	
Glides	<ul style="list-style-type: none"> • Plastic glides +\$ 30 	<p>Specify with glides.</p>	

Tip: When ordering seagull frame the arms are 6059 Sterling Dark Solid. When ordering black frame, arms are black.

Tip: 3D Microknit, lumbar, and back flexors colors match unless contrasting outer back is selected.

Tip: Base finish matches frame finish, unless seagull frame is selected, then black base is also available.

Tip: Order black base on seagull frame for lowest maintenance.

Tip: Stool ring is always black for lower cleaning maintenance, even on the seagull frame.

Tip: A headrest and a coat hanger cannot be attached on a Steelcase Series 1 chair simultaneously.

► Detailed dimensions, page 98

Specification Information

Style Number	U.S. Base Price
435B00	\$1041



Steelcase Series 1



For Canadian Pricing

Multiply U.S. Price by the Canadian price factor.

▶ See page 1 for details.

Steelcase Series 1 Accessories

Steelcase Series 1 Headrest

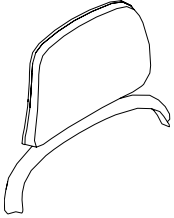

Tip: A headrest and a coat hanger cannot be attached on a Steelcase Series 1 chair simultaneously.

Standard Includes		Required to Specify
<ul style="list-style-type: none"> ▶ Need help? Product details, page 94 	<ul style="list-style-type: none"> • Headrest frame: plastic • Headrest: 3D Microknit • 3" adjustment range 	<ul style="list-style-type: none"> 1 Style number 2 Plastic color number for frame: <ul style="list-style-type: none"> 6053 Seagull 6205 Black 3 3D Microknit color number for headrest <ul style="list-style-type: none"> ▶ See <i>Surface Materials</i>, page 774.
Specification Information		
Style Number	U.S. Price	
435HEADREST	\$134	

Steelcase Series 1 Coat Hanger

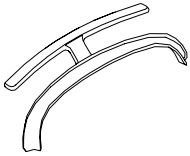

Tip: A headrest and a coat hanger cannot be attached on a Steelcase Series 1 chair simultaneously.

Standard Includes		Required to Specify
<ul style="list-style-type: none"> • Coat hanger: plastic 		<ul style="list-style-type: none"> 1 Style number 2 Plastic color number for coat hanger: <ul style="list-style-type: none"> 6053 Seagull 6205 Black
Specification Information		
Style Number	U.S. Price	
435COATHANGER	\$37	



For Canadian Pricing

Multiply U.S. Price by the Canadian price factor.

▶ See page 1 for details.